



ON Semiconductor®

# 2N7000 / 2N7002 / NDS7002A N-Channel Enhancement Mode Field Effect Transistor

## Features

- High Density Cell Design for Low  $R_{DS(ON)}$
- Voltage Controlled Small Signal Switch
- Rugged and Reliable
- High Saturation Current Capability

## Description

These N-channel enhancement mode field effect transistors are produced using ON Semiconductor's proprietary, high cell density, DMOS technology. These products have been designed to minimize on-state resistance while providing rugged, reliable, and fast switching performance. They can be used in most applications requiring up to 400 mA DC and can deliver pulsed currents up to 2 A. These products are particularly suited for low-voltage, low-current applications, such as small servo motor control, power MOSFET gate drivers, and other switching applications.

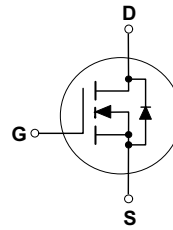
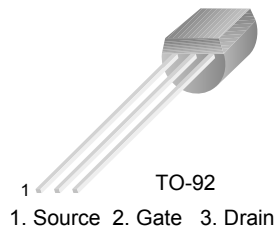

## Ordering Information

| Part Number | Marking | Package   | Packing Method | Min Order Qty / Immediate Pack Qty |
|-------------|---------|-----------|----------------|------------------------------------|
| 2N7000      | 2N7000  | TO-92 3L  | Bulk           | 10000 / 1000                       |
| 2N7000-D74Z | 2N7000  | TO-92 3L  | Ammo           | 2000 / 2000                        |
| 2N7000-D75Z | 2N7000  | TO-92 3L  | Tape and Reel  | 2000 / 2000                        |
| 2N7000-D26Z | 2N7000  | TO-92 3L  | Tape and Reel  | 2000 / 2000                        |
| 2N7002      | 702     | SOT-23 3L | Tape and Reel  | 3000 / 3000                        |
| NDS7002A    | 712     | SOT-23 3L | Tape and Reel  | 3000 / 3000                        |

2N7000 / 2N7002 / NDS7002A — N-Channel Enhancement Mode Field Effect Transistor

## Absolute Maximum Ratings

Stresses exceeding the absolute maximum ratings may damage the device. The device may not function or be operable above the recommended operating conditions and stressing the parts to these levels is not recommended. In addition, extended exposure to stresses above the recommended operating conditions may affect device reliability. The absolute maximum ratings are stress ratings only. Values are at  $T_C = 25^\circ\text{C}$  unless otherwise noted.

| Symbol         | Parameter   | Value      |        |            | Unit                       |
|----------------|---|------------|--------|------------|----------------------------|
|                |   | 2N7000     | 2N7002 | NDS7002A   |                            |
| $V_{DSS}$      | Drain-to-Source Voltage   | 60         |        |            | V                          |
| $V_{DGR}$      | Drain-Gate Voltage ( $R_{GS} \leq 1\text{ M}\Omega$ )                               | 60         |        |            | V                          |
| $V_{GSS}$      | Gate-Source Voltage - Continuous  | $\pm 20$   |        |            | V                          |
|                | Gate-Source Voltage - Non Repetitive ( $t_p < 50\ \mu\text{s}$ )                    | $\pm 40$   |        |            |                            |
| $I_D$          | Maximum Drain Current - Continuous  | 200        | 115    | 280        | mA                         |
|                | Maximum Drain Current - Pulsed  | 500        | 800    | 1500       |                            |
| $P_D$          | Maximum Power Dissipation Derated above $25^\circ\text{C}$                          | 400        | 200    | 300        | mW                         |
|                |   | 3.2        | 1.6    | 2.4        | $\text{mW}/^\circ\text{C}$ |
| $T_J, T_{STG}$ | Operating and Storage Temperature Range   | -55 to 150 |        | -65 to 150 | $^\circ\text{C}$           |
| $T_L$          | Maximum Lead Temperature for Soldering Purposes, 1/16-inch from Case for 10 Seconds | 300        |        |            | $^\circ\text{C}$           |

## Thermal Characteristics

Values are at  $T_C = 25^\circ\text{C}$  unless otherwise noted.

| Symbol          | Parameter                               | Value  |        |          | Unit                      |
|-----------------|---|--------|--------|----------|---------------------------|
|                 |   | 2N7000 | 2N7002 | NDS7002A |                           |
| $R_{\theta JA}$ | Thermal Resistance, Junction to Ambient | 312.5  | 625    | 417      | $^\circ\text{C}/\text{W}$ |

## Electrical Characteristics

Values are at  $T_C = 25^\circ\text{C}$  unless otherwise noted.

| Symbol                     | Parameter                       | Conditions   | Type               | Min. | Typ. | Max. | Unit          |
|----------------------------|---------------------------------|--|--------------------|------|------|------|---------------|
| <b>Off Characteristics</b> |                                 |  |                    |      |      |      |               |
| $BV_{DSS}$                 | Drain-Source Breakdown Voltage  | $V_{GS} = 0\text{ V}, I_D = 10\ \mu\text{A}$                         | All                | 60   |      |      | V             |
| $I_{DSS}$                  | Zero Gate Voltage Drain Current | $V_{DS} = 48\text{ V}, V_{GS} = 0\text{ V}$                          | 2N7000             |      |      | 1    | $\mu\text{A}$ |
|                            |                                 | $V_{DS} = 48\text{ V}, V_{GS} = 0\text{ V}, T_C = 125^\circ\text{C}$ |                    |      |      | 1    | mA            |
|                            |                                 | $V_{DS} = 60\text{ V}, V_{GS} = 0\text{ V}$                          | 2N7002<br>NDS7002A |      |      | 1    | $\mu\text{A}$ |
|                            |                                 | $V_{DS} = 60\text{ V}, V_{GS} = 0\text{ V}, T_C = 125^\circ\text{C}$ |                    |      |      | 0.5  | mA            |
| $I_{GSSF}$                 | Gate - Body Leakage, Forward    | $V_{GS} = 15\text{ V}, V_{DS} = 0\text{ V}$                          | 2N7000             |      |      | 10   | nA            |
|                            |                                 | $V_{GS} = 20\text{ V}, V_{DS} = 0\text{ V}$                          | 2N7002<br>NDS7002A |      |      | 100  | nA            |
| $I_{GSSR}$                 | Gate - Body Leakage, Reverse    | $V_{GS} = -15\text{ V}, V_{DS} = 0\text{ V}$                         | 2N7000             |      |      | -10  | nA            |
|                            |                                 | $V_{GS} = -20\text{ V}, V_{DS} = 0\text{ V}$                         | 2N7002<br>NDS7002A |      |      | -100 | nA            |

**Electrical Characteristics** (Continued)

| Symbol  | Parameter                         | Conditions   | Type                    | Min.  | Typ.   | Max. | Unit     |
|---|-----------------------------------|--|-------------------------|---|--------|------|----------|
| <b>On Characteristics</b>                     |                                   |  |                         |   |        |      |          |
| $V_{GS(th)}$                                  | Gate Threshold Voltage            | $V_{DS} = V_{GS}, I_D = 1 \text{ mA}$                                  | 2N7000                  | 0.8   | 2.1    | 3    | V        |
|   |                                   | $V_{DS} = V_{GS}, I_D = 250 \mu\text{A}$                               | 2N7002<br>NDS7002A      | 1   | 2.1    | 2.5  |          |
| $R_{DS(ON)}$                                  | Static Drain-Source On-Resistance | $V_{GS} = 10 \text{ V}, I_D = 500 \text{ mA}$                          | 2N7000                  |   | 1.2    | 5    | $\Omega$ |
|   |                                   | $V_{GS} = 10 \text{ V}, I_D = 500 \text{ mA}, T_C = 125^\circ\text{C}$ |                         |   | 1.9    | 9    |          |
|   |                                   | $V_{GS} = 4.5 \text{ V}, I_D = 75 \text{ mA}$                          |                         |   | 1.8    | 5.3  |          |
|   |                                   | $V_{GS} = 10 \text{ V}, I_D = 500 \text{ mA}$                          | 2N7002                  |   | 1.2    | 7.5  |          |
|   |                                   | $V_{GS} = 10 \text{ V}, I_D = 500 \text{ mA}, T_C = 100^\circ\text{C}$ |                         |   | 1.7    | 13.5 |          |
|   |                                   | $V_{GS} = 5 \text{ V}, I_D = 50 \text{ mA}$                            |                         |   | 1.7    | 7.5  |          |
|   |                                   | $V_{GS} = 5 \text{ V}, I_D = 50 \text{ mA}, T_C = 100^\circ\text{C}$   |                         |   | 2.4    | 13.5 |          |
|   |                                   | $V_{GS} = 10 \text{ V}, I_D = 500 \text{ mA}$                          | NDS7002A                |   | 1.2    | 2    |          |
|   |                                   | $V_{GS} = 10 \text{ V}, I_D = 500 \text{ mA}, T_C = 125^\circ\text{C}$ |                         |   | 2      | 3.5  |          |
|   |                                   | $V_{GS} = 5 \text{ V}, I_D = 50 \text{ mA}$                            |                         |   | 1.7    | 3    |          |
|   |                                   | $V_{GS} = 5 \text{ V}, I_D = 50 \text{ mA}, T_C = 125^\circ\text{C}$   |                         |   | 2.8    | 5    |          |
|   |                                   | $V_{DS(ON)}$   | Drain-Source On-Voltage | $V_{GS} = 10 \text{ V}, I_D = 500 \text{ mA}$ | 2N7000 |      |          |
| $V_{GS} = 4.5 \text{ V}, I_D = 75 \text{ mA}$ |                                   |  |                         | 0.14  |        | 0.4  |          |
| $V_{GS} = 10 \text{ V}, I_D = 500 \text{ mA}$ | 2N7002                            |  |                         |   | 0.6    | 3.75 |          |
| $V_{GS} = 5.0 \text{ V}, I_D = 50 \text{ mA}$ |                                   |  |                         |   | 0.09   | 1.5  |          |
| $V_{GS} = 10 \text{ V}, I_D = 500 \text{ mA}$ | NDS7002A                          |  |                         |   | 0.6    | 1    |          |
| $V_{GS} = 5.0 \text{ V}, I_D = 50 \text{ mA}$ |                                   |  |                         |   | 0.09   | 0.15 |          |
| $I_{D(ON)}$                                   | On-State Drain Current            | $V_{GS} = 4.5 \text{ V}, V_{DS} = 10 \text{ V}$                        | 2N7000                  | 75  | 600    |      | mA       |
|   |                                   | $V_{GS} = 10 \text{ V}, V_{DS} \geq 2 V_{DS(on)}$                      | 2N7002                  | 500   | 2700   |      |          |
|   |                                   | $V_{GS} = 10 \text{ V}, V_{DS} \geq 2 V_{DS(on)}$                      | NDS7002A                | 500   | 2700   |      |          |
| $g_{FS}$                                      | Forward Transconductance          | $V_{DS} = 10 \text{ V}, I_D = 200 \text{ mA}$                          | 2N7000                  | 100   | 320    |      | mS       |
|   |                                   | $V_{DS} \geq 2V_{DS(ON)}, I_D = 200 \text{ mA}$                        | 2N7002                  | 80  | 320    |      |          |
|   |                                   | $V_{DS} \geq 2V_{DS(ON)}, I_D = 200 \text{ mA}$                        | NDS7002A                | 80  | 320    |      |          |

### Electrical Characteristics (Continued)

| Symbol  | Parameter   | Conditions   | Type               | Min. | Typ. | Max. | Unit |
|---|---|--|--------------------|------|------|------|------|
| <b>Dynamic Characteristics</b>                                |   |  |                    |      |      |      |      |
| $C_{iss}$   | Input Capacitance                                     | $V_{DS} = 25\text{ V}, V_{GS} = 0\text{ V},$<br>$f = 1.0\text{ MHz}$   | All                |      | 20   | 50   | pF   |
| $C_{oss}$   | Output Capacitance                                    |  | All                |      | 11   | 25   |      |
| $C_{rss}$   | Reverse Transfer Capacitance                          |  | All                |      | 4    | 5    |      |
| $t_{on}$  | Turn-On Time  | $V_{DD} = 15\text{ V}, R_L = 25\ \Omega,$<br>$I_D = 500\text{ mA}, V_{GS} = 10\text{ V},$<br>$R_{GEN} = 25\ \Omega$  | 2N7000             |      |      | 10   | ns   |
|   |   | $V_{DD} = 30\text{ V}, R_L = 150\ \Omega,$<br>$I_D = 200\text{ mA}, V_{GS} = 10\text{ V},$<br>$R_{GEN} = 25\ \Omega$ | 2N7002<br>NDS7002A |      |      | 20   |      |
| $t_{off}$   | Turn-Off Time   | $V_{DD} = 15\text{ V}, R_L = 25\ \Omega,$<br>$I_D = 500\text{ mA}, V_{GS} = 10\text{ V},$<br>$R_{GEN} = 25\ \Omega$  | 2N7000             |      |      | 10   | ns   |
|   |   | $V_{DD} = 30\text{ V}, R_L = 150\ \Omega,$<br>$I_D = 200\text{ mA}, V_{GS} = 10\text{ V},$<br>$R_{GEN} = 25\ \Omega$ | 2N7002<br>NDS7002A |      |      | 20   |      |
| <b>Drain-Source Diode Characteristics and Maximum Ratings</b> |   |  |                    |      |      |      |      |
| $I_S$   | Maximum Continuous Drain-Source Diode Forward Current |  | 2N7002             |      |      | 115  | mA   |
|   |   |  | NDS7002A           |      |      | 280  |      |
| $I_{SM}$  | Maximum Pulsed Drain-Source Diode Forward Current     |  | 2N7002             |      |      | 0.8  | A    |
|   |   |  | NDS7002A           |      |      | 1.5  |      |
| $V_{SD}$  | Drain-Source Diode Forward Voltage                    | $V_{GS} = 0\text{ V},$<br>$I_S = 115\text{ mA}^{(1)}$  | 2N7002             |      | 0.88 | 1.5  | V    |
|   |   | $V_{GS} = 0\text{ V},$<br>$I_S = 400\text{ mA}^{(1)}$  | NDS7002A           |      | 0.88 | 1.2  |      |

**Note:**

1. Pulse test : Pulse Width  $\leq 300\ \mu\text{s}$ , Duty Cycle  $\leq 2\%$ .

# Typical Performance Characteristics

2N7000 / 2N7002 / NDS7002A

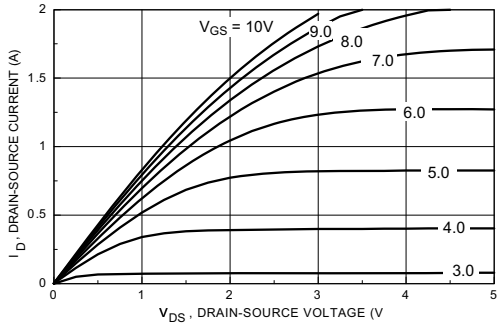

Figure 1. On-Region Characteristics

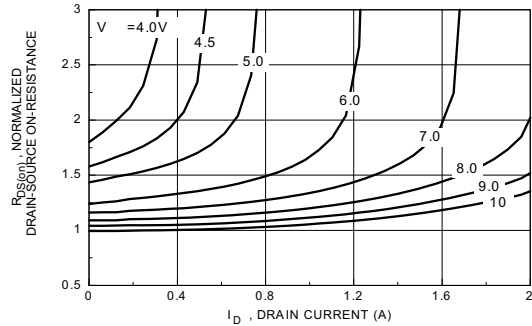

Figure 2. On-Resistance Variation with Gate Voltage and Drain Current

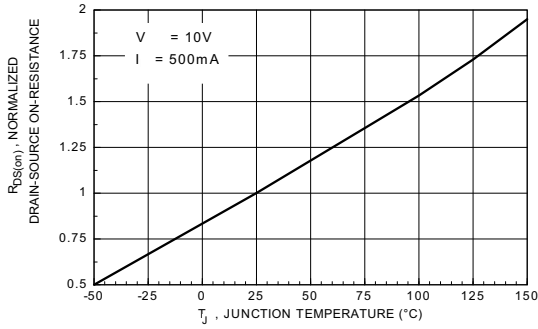

Figure 3. On-Resistance Variation with Temperature

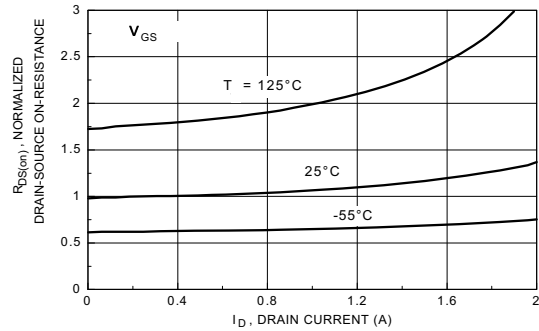

Figure 4. On-Resistance Variation with Drain Current and Temperature

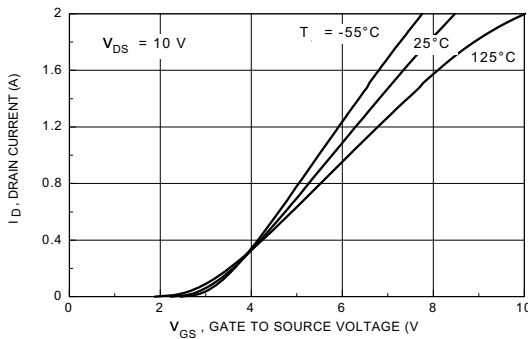

Figure 5. Transfer Characteristics

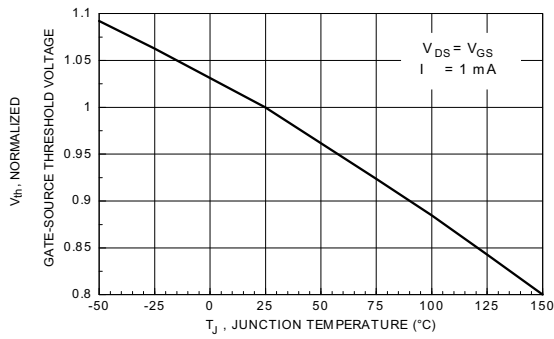
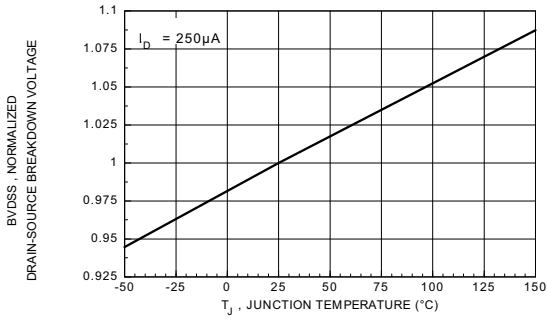

Figure 6. Gate Threshold Variation with Temperature

## Typical Performance Characteristics (Continued)

### 2N7000 / 2N7002 / NDS7002A



**Figure 7. Breakdown Voltage Variation with Temperature**

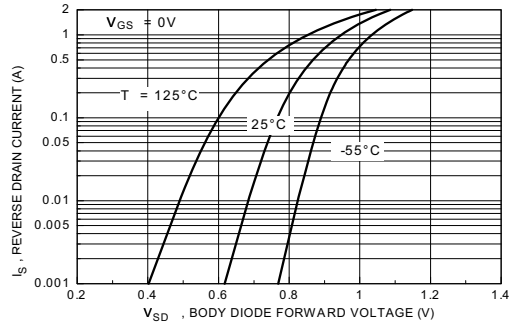

**Figure 8. Body Diode Forward Voltage Variation with Temperature**

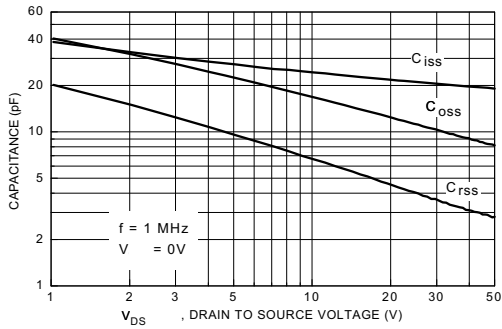

**Figure 9. Capacitance Characteristics**

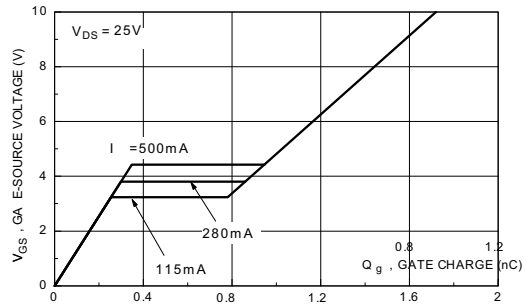

**Figure 10. Gate Charge Characteristics**

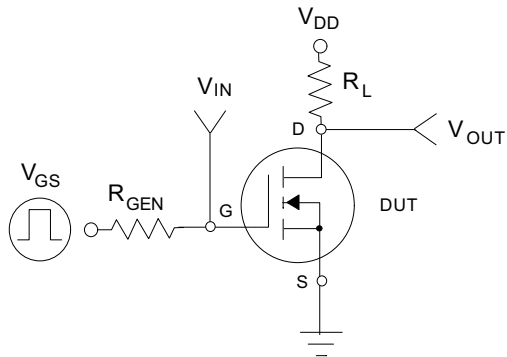

**Figure 11. Switching Test Circuit**

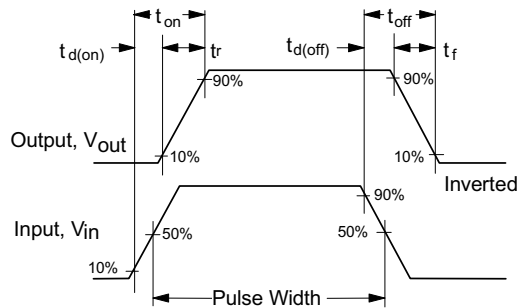

**Figure 12. Switching Waveforms**

Typical Performance Characteristics (Continued)

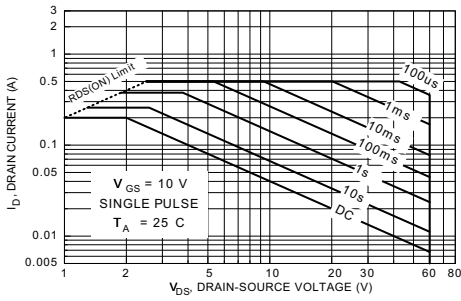

Figure 13. 2N7000 Maximum Safe Operating Area

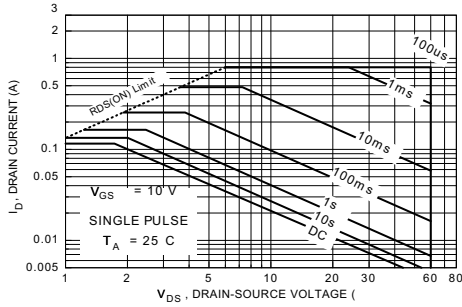

Figure 14. 2N7002 Maximum Safe Operating Area

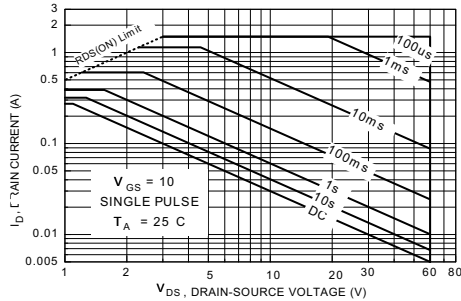

Figure 15. NDS7000A Maximum Safe Operating Area

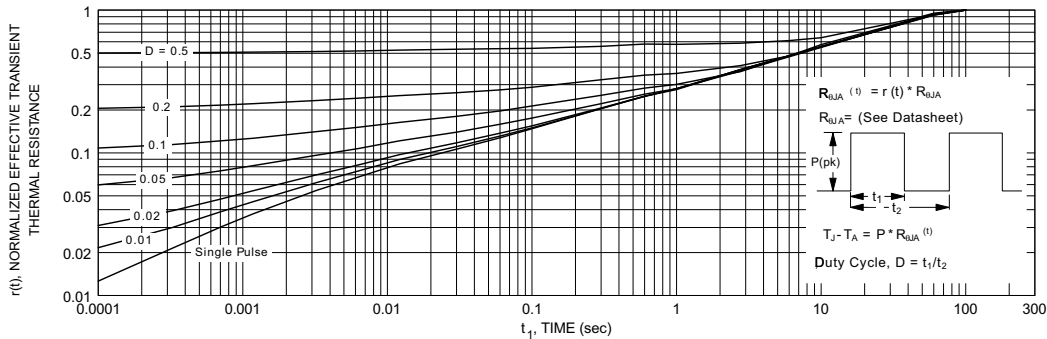

Figure 16. TO-92, 2N7000 Transient Thermal Response Curve

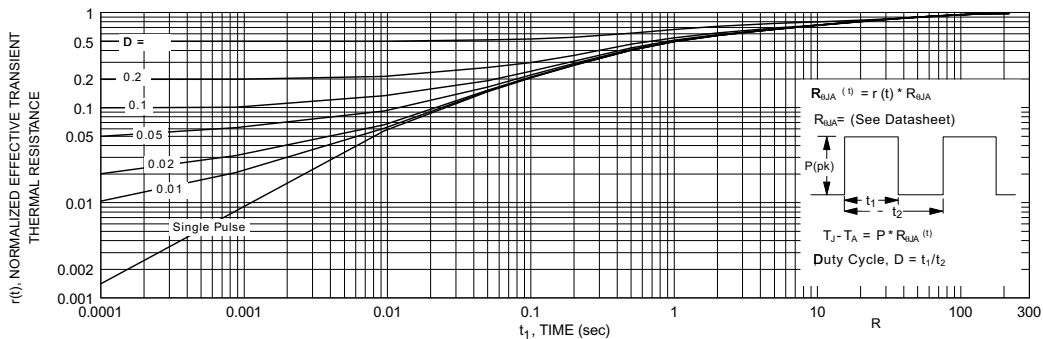

Figure 17. SOT-23, 2N7002 / NDS7002A Transient Thermal Response Curve

ON Semiconductor and  are trademarks of Semiconductor Components Industries, LLC dba ON Semiconductor or its subsidiaries in the United States and/or other countries. ON Semiconductor owns the rights to a number of patents, trademarks, copyrights, trade secrets, and other intellectual property. A listing of ON Semiconductor's product/patent coverage may be accessed at [www.onsemi.com/site/pdf/Patent-Marking.pdf](http://www.onsemi.com/site/pdf/Patent-Marking.pdf). ON Semiconductor reserves the right to make changes without further notice to any products herein. ON Semiconductor makes no warranty, representation or guarantee regarding the suitability of its products for any particular purpose, nor does ON Semiconductor assume any liability arising out of the application or use of any product or circuit, and specifically disclaims any and all liability, including without limitation special, consequential or incidental damages. Buyer is responsible for its products and applications using ON Semiconductor products, including compliance with all laws, regulations and safety requirements or standards, regardless of any support or applications information provided by ON Semiconductor. "Typical" parameters which may be provided in ON Semiconductor data sheets and/or specifications can and do vary in different applications and actual performance may vary over time. All operating parameters, including "Typicals" must be validated for each customer application by customer's technical experts. ON Semiconductor does not convey any license under its patent rights nor the rights of others. ON Semiconductor products are not designed, intended, or authorized for use as a critical component in life support systems or any FDA Class 3 medical devices or medical devices with a same or similar classification in a foreign jurisdiction or any devices intended for implantation in the human body. Should Buyer purchase or use ON Semiconductor products for any such unintended or unauthorized application, Buyer shall indemnify and hold ON Semiconductor and its officers, employees, subsidiaries, affiliates, and distributors harmless against all claims, costs, damages, and expenses, and reasonable attorney fees arising out of, directly or indirectly, any claim of personal injury or death associated with such unintended or unauthorized use, even if such claim alleges that ON Semiconductor was negligent regarding the design or manufacture of the part. ON Semiconductor is an Equal Opportunity/Affirmative Action Employer. This literature is subject to all applicable copyright laws and is not for resale in any manner.

## PUBLICATION ORDERING INFORMATION

### LITERATURE FULFILLMENT:

Literature Distribution Center for ON Semiconductor  
19521 E. 32nd Pkwy, Aurora, Colorado 80011 USA  
**Phone:** 303-675-2175 or 800-344-3860 Toll Free USA/Canada  
**Fax:** 303-675-2176 or 800-344-3867 Toll Free USA/Canada  
**Email:** [orderlit@onsemi.com](mailto:orderlit@onsemi.com)

**N. American Technical Support:** 800-282-9855 Toll Free  
USA/Canada  
**Europe, Middle East and Africa Technical Support:**  
Phone: 421 33 790 2910  
**Japan Customer Focus Center**  
Phone: 81-3-5817-1050

**ON Semiconductor Website:** [www.onsemi.com](http://www.onsemi.com)  
**Order Literature:** <http://www.onsemi.com/orderlit>  
For additional information, please contact your local  
Sales Representative