

FUSE CLIPS

Underwriters Laboratories, Inc.
Recognized Component Program –
UL File Number E354010



UL file number E354010 has been assigned to Keystone Electronics' fuse clips and holders with end stops. (Refer to pages 44-47) Indicating recognition by Underwriters Laboratories Inc. that they are in compliance with their component program.

- Available for 5mm, 1AG, 2AG, 3AG, 5AG, 7AG & 8AG sizes
- Low profile, space saving
- Low contact resistance
- Withstands shock and vibration
- Rated 6.3 to 30 Amps
- Custom designs and modifications available to your specifications

PC THRU MOUNT TYPES

- Snap-fit design enhances assembly and PC retention for wave soldering
- Available with orientation legs to assure proper PC installation
- Available with or without end stops

SURFACE MOUNT & RIVET TYPES

- Available with solder lugs or quick-fit tabs .187 (4.7), .205 (5.2)

Refer to pages 48-51 for Fuse Clip Layout and Mounting Details

5mm PC Clips

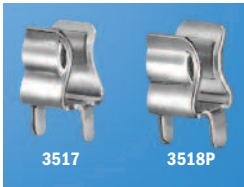

MATERIAL:
 .020 (.51) Brass, Tin Plate
UL Current Rating: 15 Amps

CAT. NO.	A	B
3517	.060 (1.5)	.060 (1.5)
3518P	.060 (1.5)	.093 (2.4)

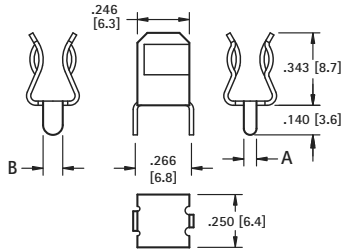

With or Without Orientation Legs
 Optional cover available - Cat. No. 3517C



• With snap-in PC legs
MATERIAL:
 .020 (.51) Brass, Tin Plate
UL Current Rating: 15 Amps

CAT. NO.	A	B
3512	.060 (1.5)	.060 (1.5)
3512P	.060 (1.5)	.093 (2.4)

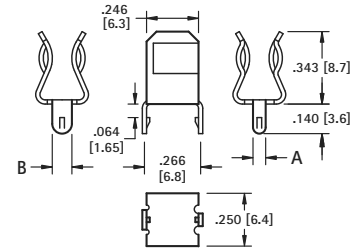

With or Without Orientation Legs
 Optional cover available - Cat. No. 3517C

FUSE CLIPS



MATERIAL:
 .016 (.41) Brass, Tin Plate
UL Current Rating: 6.3 Amps

CAT. NO. 3520

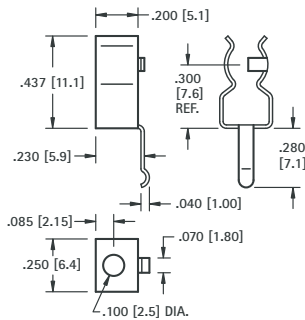

MATERIAL:
 .016 (.41) Brass, Tin Plate
UL Current Rating: 15 Amps

CAT. NO. 3519

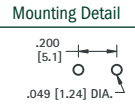
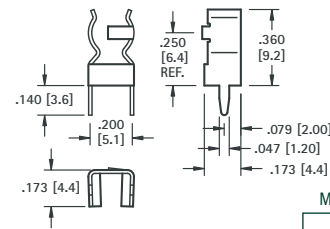

2AG or 5mm



MATERIAL: .016 (.41) Brass, Tin Plate
UL Current Rating: 15 Amps

CAT. NO.	ON TAPE BULK	ON TAPE & REEL	PC LEGS	END STOP
3521	—	—	YES	YES
3621	—	—	YES	NO*
3561	3561TR	—	NO	YES
3622	3622TR	—	NO	NO*

Table & Reel Specs: 16mm wide, 12mm pitch, 13 inch reel (500 pieces per reel)

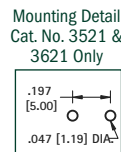
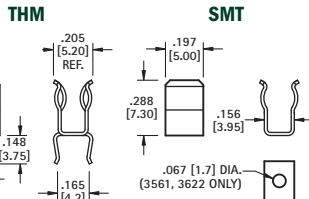

5mm/3AG



MATERIAL:
 .016 (.41) Brass, Tin Plate
UL Current Rating: 15 Amps

CAT. NO. 3562

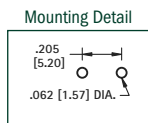
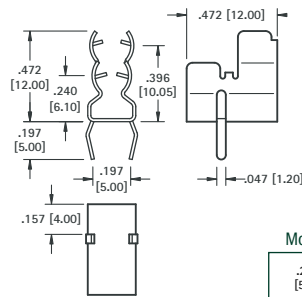

4AG (9/32 Dia.)



MATERIAL:
 .020 (.51) Brass, Nickel Plate
Current Rating: 15 Amps

CAT. NO. 3565 (Without End Stops)*

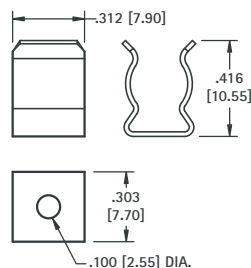

5AG (13/32 Dia.) - Solar Protection Fuse



MATERIAL:
 .030 (.76) Brass, Tin Plate
UL Current Rating: 30 Amps

CAT. NO. 3566

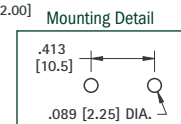
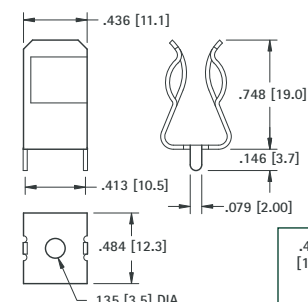

*Fuse clips without end stops are not UL recognized