

THICK FILM CHIP RESISTORS



RMC

RMC 20, 16S, 16, 10, 18, 14, 12S, 12, 01S, 01

MEGASTAR-OHM thick film chip resistors are suitable for a wide range of soldering methods and are ideal for use with high speed automatic insertion machinery.

On a high grade ceramic body (aluminium oxide) a metal glaze layer is screened.

Depending on composition of the metal glaze different resistance values can be obtained.

At both ends, a contact is made in such a way the optimum solderability is guaranteed.

This is achieved by applying three layers. The resistive layer is covered with a protective coat.

Features

1. A wide range of values and power rating for design flexibility.
2. Thick film Ruthenium Oxide (RuO₂) element for excellent stability.
3. Operating temperature ranges from -55°C to +125°C.
4. RMC 1/10W will withstand 1/8W dissipation with sufficient mounting space.
5. RMC 1/8W will withstand 1/4W dissipation with sufficient mounting space.
6. Zero OHM (0.05Ω max) jumper available in all sizes.
7. Resistor values available as low as 0.01OHM.

Dimensions and Structure

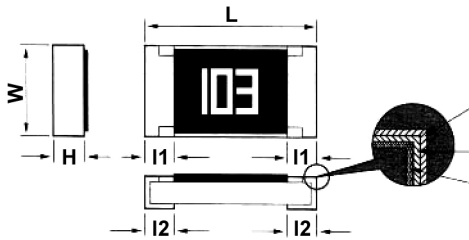

Dimensions: mm					
Style	L	W	l1	l2	H
RMC20 (0201)	0.60 ± 0.03	0.30 ± .030	0.15 ± 0.05	0.15 ± 0.05	0.23 ± 0.03
RMC16S (0402)	1.00 ± 0.10	0.50 ± 0.05	0.20 ± 0.10	0.25 ± 0.10	0.35 ± 0.05
RMC16 (0603)	1.60 ± 0.10	0.85 ± 0.10	0.30 ± 0.20	0.30 ± 0.20	0.45 ± 0.05
RMC10 (0805)	2.10 ± 0.10	1.30 ± 0.10	0.40 ± 0.20	0.40 ± 0.20	0.50 ± 0.05
RMC18 (1206)	3.10 ± 0.10	1.60 ± 0.10	0.45 ± 0.20	0.40 ± 0.20	0.55 ± 0.10
RMC14 (1210)	3.10 ± 0.10	2.60 ± 0.10	0.50 ± 0.25	0.40 ± 0.20	0.55 ± 0.05
RMC12S (1812)	4.50 ± 0.10	3.00 ± 0.10	0.55 ± 0.10	0.80 ± 0.10	0.55 ± 0.05
RMC12 (2010)	5.00 ± 0.10	2.50 ± 0.10	0.60 ± 0.25	0.40 ± 0.20	0.55 ± 0.05
RMC01S (1218)	3.10 ± 0.10	4.60 ± 0.10	0.45 ± 0.10	0.40 ± 0.10	0.55 ± 0.05
RMC01 (2512)	6.35 ± 0.10	3.20 ± 0.10	0.60 ± 0.25	0.40 ± 0.20	0.55 ± 0.05

PART NUMBERING SYSTEM

RMC

10

— XXX or XXXX

J

T

Type
RMC

Size	
Code	Wattage (Size)
20	1/20W (0201)
16S	1/16W (0402)
16	1/10W (0603)
10	1/8W (0805)
18	1/4W (1206)
14	1/3W (1210)
12S	0.5W (1812)
12	3/4W (2010)
01S	1.0W (1218)
01	1.0W (2512)

Resistance Tolerance	
D	±0.5%
F	±1%
G	±2%
J	±5%
*Omit tolerance for jumper	

Packaging	
B	Bulk
T	7" Tape & Reel
T10	10" Tape & Reel
T13	13" Tape & Reel
Please refer to packaging explanation on page 4	

Resistance Value: 3 DIGIT CODE (1% and 5% Tolerance E24 xxx)								
Code	1R0	10R	101	102	103	104	105	000
Values	1Ω	10Ω	100Ω	1KΩ	10KΩ	100KΩ	1MΩ	JUMPER

First two digits are significant figures and third digit is number of zeros.

Letter "R" indicates decimal values under 100 ohms.

Resistance Value: 4 DIGIT CODE (1% Tolerance E96 xxxx)						
Code	10R0	1000	1001	1002	1003	1004
Values	10Ω	100Ω	1K	10K	100K	1M

First three digits are significant figures and fourth digit is number of zeros.

Letter "R" indicates decimal values under 100 ohms.

THICK FILM CHIP RESISTORS



RMC

RMC 20, 16S, 16, 10, 18, 14, 12S, 12, 01S, 01

LEADFREE
RoHS Compliant

Performance Characteristics

Style	RMC20 (0201)	RMC16S (0402)	RMC16 (0603)	RMC10 (0805)	RMC18 (1206)	RMC14 (1210)	RMC12S (1812)	RMC12 (2010)	RMC01S (1218)	RMC01 (2512)
Package Size	0201	0402	0603	0805	1206	1210	1812	2010	1218	2512
Power Rating @ 70°C	1/20W	1/16W	1/10W	1/8W	1/4W	1/3W	0.5W	3/4W	1.0W	1.0W
Maximum Working Voltage	15V	25V	50V	150V	200V	200V	200V	200V	200V	200V
Maximum Overload Voltage	30V	50V	100V	300V	400V	400V	400V	400V	400V	400V
Current Rating of Jumper Maximum (Zero Ohm)	0.5A	1A	1A	2A	2A	2A	2A	2A	2A	2A
Resistance Range 1%, E-96 1% and 5%, E-24 Zero Ohm Jumper < 0.05Ω	0.51R-10M 0.51R-10M	0.05R-10M 0.05R-10M	0.02R-10M 0.01R-10M	0.01R-10M 0.01R-22M	0.01R-10M 0.01R-22M	0.01R-1M 0.01R-10M	0.01R-1M 0.01R-10M	0.01R-1M 0.01R-10M	0.01R-1M 0.01R-10M	0.01R-1M 0.01R-10M
Temperature Coefficient	0.01Ω to <1Ω: ±500PPM, 1Ω to <10Ω: 200PPM 10Ω to 1MΩ: 100PPM, >1MΩ to 20MΩ: 200PPM 20.5MΩ to 100MΩ									
Operating Temp. Range	-55°C to +125°C		-55°C to +155°C							

Characteristics

Performance	Test Method	1% Tolerance	5% Tolerance
Temperature Coefficient (by Type)	MIL-STD-202F, Method 304 -55°C to 125°C	± 100 PPM/°C	± 200 PPM/°C
Thermal Shock	MIL-STD-202F, Method 107 -55°C to 125°C	± (0.5% + 0.05Ω)	± (1.0% + 0.05Ω)
Low Temperature Operation	MIL-R-55342D, Para. 4.7.4 One hour at -65°C followed by 45 minutes RCWV	± (0.5% + 0.05Ω)	± (1.0% + 0.05Ω)
Short Time Overload	MIL-R-55342D, Para. 4.7.5 2.5 times RCWV for 5 seconds	± (1.0% + 0.05Ω)	± (2.0% + 0.05Ω)
High Temperature	MIL-R-55342D, Para.4.7.6 125°C for 100 hours	± (1.0% + 0.05Ω)	± (2.0% + 0.10Ω)
Resistance to Soldering Heat	JIS C 5202 Soldered to test board at 260°C ± 5°C for 10 seconds (solder bath)	± (0.5% + 0.05Ω)	± (1.0% + 0.05Ω)
Moisture Resistance	MIL-STD-202F, Method 106 10 cycles. Total 240 hours.	± (0.5% + 0.05Ω)	± (2.0% + 0.05Ω)
Life	MIL-STD-202F, Method 108A 100 hours at 70°C RWV intermittent	± (1.0% + 0.05Ω)	± (3.0% + 0.10Ω)
Solderability	JIS C 5202 235°C for 2 seconds	95% min. coverage	95% min. coverage
Bending Strength	Unit mounted in center 208 90mm board length, deflected 5mm in either direction for 10 seconds.	± (1.0% + 0.05Ω)	± (1.0% + 0.05Ω)

Markings

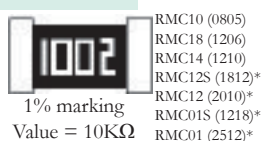
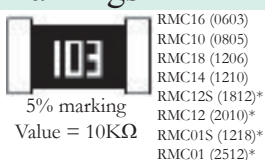

Marking Explanation

- 1% and 5% tolerance: 3 digits, first 2 digits are significant figures, third digit is number of zeros.
- Letter "R" is decimal point.
- 1% tolerance: 4 digits, first 3 digits are significant figures. Letter "R" is decimal point.
- 0603 1%: EIA-96 marking (see page 4)
- 0402 no marking
- * 1218, 1812, 2010 & 2512 (5% & 1% may contain 4-DIGIT codes)

Packaging Explanation

- Paper tape per 7" reel
- RMC20/16S: 10,000pcs
- RMC16/10/18/14: 5,000pcs
- Embossed plastic tape per 7" reel
- RMC10/18/14/12, 12S, 01S: 4,000pcs
- RMC01: 2,000pcs
- Bulk bag: 5,000 per plastic bag, 2 bags per box
- Standard packaging is 8mm tape reel per EIA481

Derating Curve

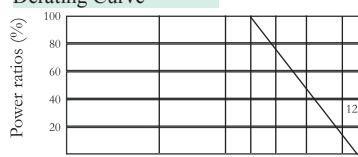

Maximum allowable continuous voltage for all resistors is the lower of the two values:
 "maximum working voltage" as specified or
 $\text{Power rating (W)} \times \text{resistance } (\Omega)$

RMC 20, 16S, 16, 10, 18, 14, 12S, 12, 01S, 01

Marking Explanation

1- For jumper 0 ohm.



2- 1% and 5% Tolerance (3 digit system)

First two (2) digits are significant figures and third digit is number of zeros.

Letter "R" indicates decimal values under 100 ohms.

Applicable for sizes: 0603, 0805, 1206, 1210, 1218, 1812, 2010 and 2512 using standard E-24 values as follows.



100	110	120	130	150	160	180	200	220	240	270	300	330	360	390	430	470	510	560	620	680	750	820	910
-----	-----	-----	-----	-----	-----	-----	-----	-----	-----	-----	-----	-----	-----	-----	-----	-----	-----	-----	-----	-----	-----	-----	-----

Example:

Code	10R	470	101	102	103	104	105
Values	10Ω	47Ω	100Ω	1KΩ	10KΩ	100KΩ	1MΩ

3- 1% Tolerance (4 digit system)

First three (3) digits are significant figures and fourth digit is number of zeros.

Letter "R" indicates decimal values under 100 ohms.

Applicable for sizes: 0805, 1206, 1210, 1218, 1812 using standard E-96 values.



Example:

Code	10R0	1000	1001	1002	1003	1004	1332	3243
Values	10Ω	100Ω	1KΩ	10KΩ	100KΩ	1MΩ	13.2KΩ	324KΩ

4- For 0201 and 0402 size

No marking available on chip.



3 digit system with alternate marking method using standard E-96 values and multiplier code to determine the 3 digit EIA-96 part marking scheme



Coding Formula

XX X

Multiplier Code

Code	A	B	C	D	E	F	G	H	X	Y	Z
Multiplier	10 ⁰	10 ¹	10 ²	10 ³	10 ⁴	10 ⁵	10 ⁶	10 ⁷	10 ⁻¹	10 ⁻²	10 ⁻³

E-96 for 0603 resistance code

Standard E-96 Values and 0603 Resistance Codes

Value	Code	Value	Code	Value	Code	Value	Code
100	01	102	02	105	03	107	04
110	05	113	06	115	07	118	08
121	09	124	10	127	11	130	12
133	13	137	14	140	15	143	16
147	17	150	18	154	19	158	20
162	21	165	22	169	23	174	24
178	25	182	26	187	27	191	28
196	29	200	30	205	31	210	32
215	33	221	34	226	35	232	36
237	37	243	38	249	39	255	40
261	41	267	42	274	43	280	44
287	45	294	46	301	47	309	48
316	49	324	50	332	51	340	52
348	53	357	54	365	55	374	56
383	57	392	58	402	59	412	60
422	61	432	62	442	63	453	64
464	65	475	66	487	67	499	68
511	69	523	70	536	71	549	72
562	73	576	74	590	75	604	76
619	77	634	78	649	79	665	80
681	81	698	82	715	83	732	84
750	85	768	86	787	87	806	88
825	89	845	90	866	91	887	92
909	95	931	94	953	95	976	96

Examples on Markings for 0603 size, 1% Chip Resistors

Resistance Value = $\frac{(\text{E96 value})}{[\text{E96 code}]} \times \frac{(\text{multiplier})}{[\text{multiplier code}]} = [\text{E96 code}][\text{multiplier code}] = \text{marking}$

$$11.3\text{K}\Omega = \frac{113}{06} \times \frac{10^2}{C} = 06C$$



$$47.5\Omega = \frac{475}{66} \times \frac{10^{-1}}{X} = 66X$$



$$150\Omega = \frac{150}{18} \times \frac{10^3}{D} = 18D$$



$$1\text{Meg}\Omega = \frac{100}{01} \times \frac{10^4}{E} = 01E$$



Part Marking Instructions for 0603 size chip, 1% ToL Resistor

As shown in the chart, a two-digit number is assigned to each standard R-value per (E96). This is followed by an alpha code system which is a multiplier for the value table. Each letter from A-Z represent a specific multiplier. By combining a specific two-digit number and a letter you have the complete coding formula for (E96) R-value codes.

THICK FILM CHIP RESISTORS



RMC

RMC 20, 16S, 16, 10, 18, 14, 12S, 12, 01S, 01

Tape & Reel Specifications

NOTE: Applicable to II chip resistors with the same case size.
Such as RMC, RGC, RLC, HMC, RNC, FC, LTC and CRF.

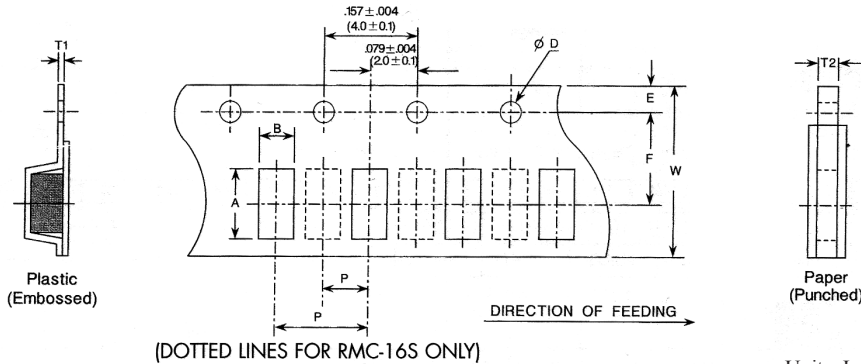

Units: Inches (mm)

Dimensions	A	B	W	E	F	T1	T2	P	D	Reel - Paper Tape			Reel - Embossed Tape	
										7" (178mm)	10" Reel (254mm)	13" Reel (330mm)	7" Reel (178mm)	13" Reel (330mm)
RMC20 (0201)	.027 ± .002 (.68 ± .05)	.015 ± .002 (.38 ± .05)	.315 ± .008 (8.0 ± .2)	.069 ± .004 (1.75 ± .1)	.138 ± .002 (3.5 ± .05)	-	.017 ± .004 (.42 ± .1)	.079 ± .004 (2.0 ± .1)	.059 ± .004/-0 (1.5 ± .1/-0)	10,000	-	-	-	-
RMC16S (0402)	.45 ± .004 (1.15 ± .1)	.026 ± .004 (.65 ± .1)	.315 ± .008 (8.0 ± .2)	.069 ± .004 (1.75 ± .1)	.138 ± .002 (3.5 ± .05)	-	.018 ± .004 (.45 ± .1)	.079 ± .004 (2.0 ± .1)	.059 ± .004/-0 (1.5 ± .1/-0)	10,000	20,000	-	-	-
RMC16 (0603)	.075 ± .004 (1.9 ± .1)	.043 ± .004 (1.1 ± .1)	.315 ± .008 (8.0 ± .2)	.069 ± .004 (1.75 ± .1)	.138 ± .002 (3.5 ± .05)	-	.024 ± .004 (.60 ± .1)	.157 ± .004 (4.0 ± .1)	.059 ± .004/-0 (1.5 ± .1/-0)	5,000	10,000	20,000	-	-
RMC10 (0805)	.094 ± .004 (2.4 ± .01)	.065 ± .004 (1.65 ± .1)	.315 ± .008 (8.0 ± .2)	.069 ± .004 (1.75 ± .1)	.138 ± .002 (3.5 ± .05)	-	.030 ± .004 (.75 ± .1)	.157 ± .004 (4.0 ± .1)	.059 ± .004/-0 (1.5 ± .1/-0)	5,000	10,000	20,000	-	-
RMC18 (1206)	.138 ± .004 (3.5 ± .1)	.075 ± .004 (1.9 ± .1)	.315 ± .008 (8.0 ± .2)	.069 ± .004 (1.75 ± .1)	.138 ± .002 (3.5 ± .05)	-	.030 ± .004 (.75 ± .1)	.157 ± .004 (4.0 ± .1)	.059 ± .004/-0 (1.5 ± .1/-0)	5,000	10,000	20,000	-	-
RMC14 (1210)	.138 ± .004 (3.5 ± .1)	.11 ± .004 (2.8 ± .1)	.315 ± .008 (8.0 ± .2)	.069 ± .004 (1.75 ± .1)	.138 ± .002 (3.5 ± .05)	-	.030 ± .004 (.75 ± .1)	.157 ± .004 (4.0 ± .1)	.059 ± .004/-0 (1.5 ± .1/-0)	5,000	10,000	-	-	-
RMC12S (1812)	.181 ± .008 (4.6 ± .2)	.130 ± .008 (3.30 ± .2)	.472 ± .004 (12.0 ± .1)	.069 ± .004 (1.75 ± .1)	.217 ± .002 (5.5 ± .05)	.009 ± .004 (.23 ± .1)	-	.157 ± .004 (4.0 ± .1)	.059 ± .004/-0 (1.5 ± .1/-0)	-	-	4,000	-	8,000
RMC12 (2010)	.220 ± .008 (5.6 ± .2)	.11 ± .008 (2.8 ± .2)	.472 ± .004 (12.0 ± .1)	.069 ± .004 (1.75 ± .1)	.217 ± .002 (5.5 ± .05)	.008 ± .002 (.23 ± .1)	-	.157 ± .004 (4.0 ± .1)	.059 ± .004/-0 (1.5 ± .1/-0)	-	-	-	4,000	8,000
RMC01S (1218)	.181 ± .008 (4.6 ± .2)	.130 ± .008 (3.30 ± .2)	.472 ± .004 (12.0 ± .1)	.069 ± .004 (1.75 ± .1)	.217 ± .002 (5.5 ± .05)	.009 ± .004 (.23 ± .1)	-	.157 ± .004 (4.0 ± .1)	.059 ± .004/-0 (1.5 ± .1/-0)	-	-	4,000	-	8,000
RMC01 (2512)	.264 ± .008 (6.7 ± .2)	.142 ± .008 (3.6 ± .2)	.472 ± .004 (12.0 ± .1)	.069 ± .004 (1.75 ± .1)	.217 ± .002 (5.5 ± .05)	.008 ± .002 (.23 ± .1)	-	.315 ± .004 (8.0 ± .1)	.059 ± .004/-0 (1.5 ± .1/-0)	-	-	-	4,000	8,000

*NOTE: Dimensions are reference only.

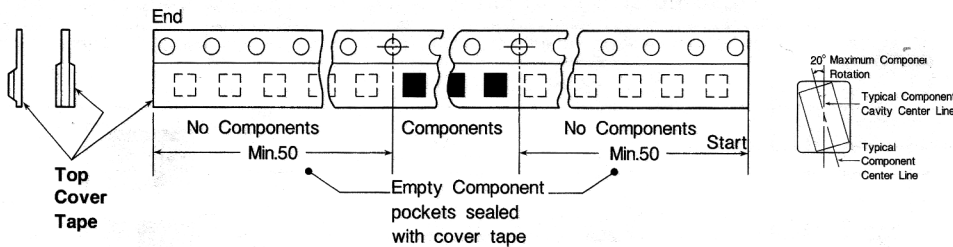

Paper Carrier (T)

Embossed Plastic Carrier (TE)

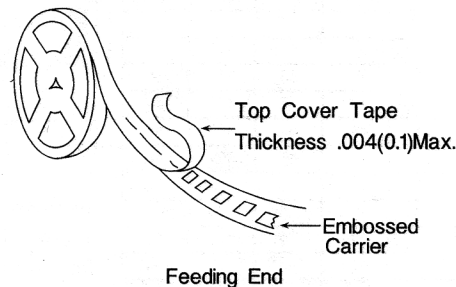
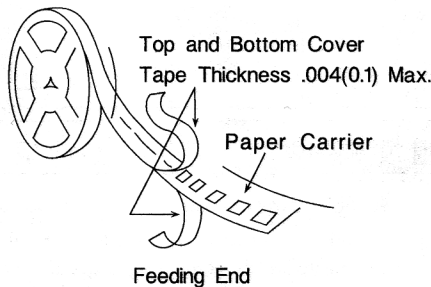

MEGASTAR-OHM surface mount tape & reel packaging complies with EIA STD. 481.

RMC 20, 16S, 16, 10, 18, 14, 12S, 12, 01S, 01

Structure of RMC Series for Lead Free & RoHS Compliant Resistor.

Diagram with material identification.

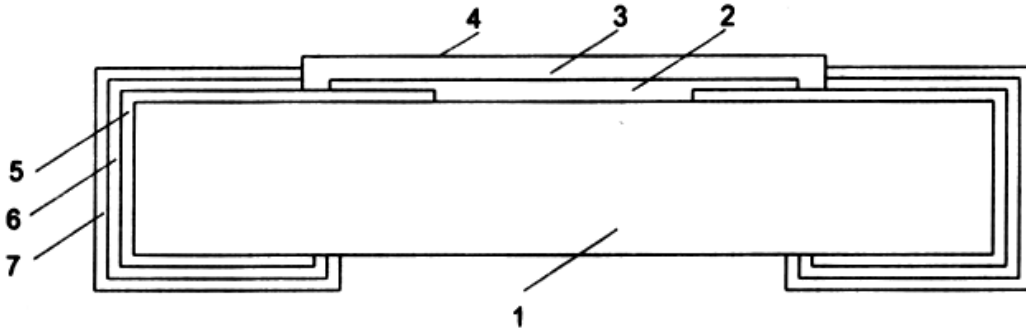

No.	Items	Materials
1	Substrate	Ceramic Alumina (Al ₂ O ₃)
2	Resistive Element	Resistor Paste (RuO ₂)
3	Protective Coating	G1 Glass, G2 Epoxy
4	Marking	Ink
5	Inner Terminal	Inner Conductor(Ag)
6	1st Plating	Nickel Layer (Ni)
7	2nd Plating	Tin Layer (Sn)

RMC SMD resistor soldering information.

Recommended condition for Reflow Soldering.

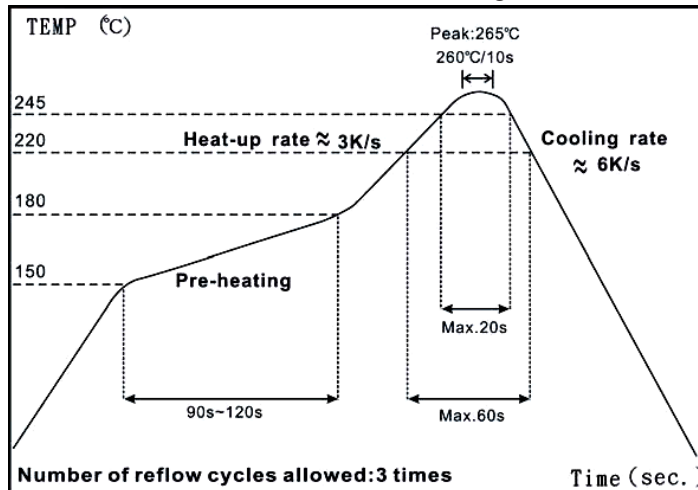

- 1- Time above liquidus (220°C): Max. 60 sec.
- 2- Time at maximum temperature point 260°C: 10 sec.
- 3- Time at preheat period (150-180°C): 90s~120s.

Recommended condition for Wave Soldering.

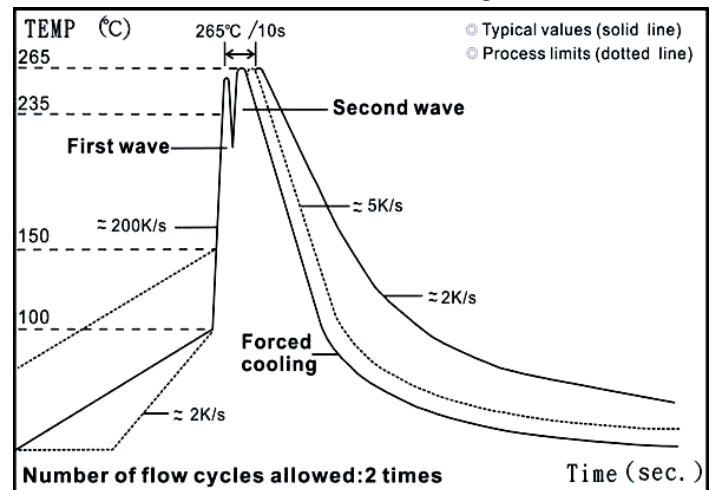

- 1- Time at maximum temperature point 265°C: 10 sec.
- 2- Max gradient at heating: 200K/s/