

Transient Voltage Suppressors (TVS) Data Sheet

Features

- For surface mounted applications in order to optimize board space
- Low profile package
- Built-in strain relief
- Glass passivated junction
- Low inductance
- Excellent clamping capability
- 5000W peak pulse power capability at 10/1000μs waveform, repetition rate (duty cycle): 0.01%
- Fast response time
- Typical I_R less than 2μA above 22V
- High Temperature soldering: 260°C/10 seconds at terminals
- Plastic package has underwriters laboratory flammability 94V-0
- Meets MSL level 1, per J-STD-020



Mechanical Data

- Case: JEDEC DO-214AB. Molded plastic over glass passivated junction
- Terminal: Solder plated, solderable per MIL-STD-750, Method 2026
- Polarity: Color band denotes cathode except bi-directional models
- Standard Packaging: 16mm tape (EIA STD RS-481)
- Weight: 0.30g

Applications

- I/O interface AC/DC power supply
- Low frequency signal transmission line (RS232, RS485, etc.)

Maximum Ratings and Characteristics

Ratings at 25°C ambient temperature unless otherwise specified.

Rating	Symbol	Value	Units
Peak pulse power dissipation at 10/1000μs waveform (Note1, Note2, Fig.1)	P_{PPM}	Minimum 5000	Watts
Peak pulse current of at 10/1000μs waveform (Note 1, Fig.3)	I_{PPM}	See Table	Amps
Steady state power dissipation at $T_A=50$ (Fig.5)	$P_{M(AV)}$	6.5	Watts
Peak forward surge current, 8.3ms single half sine-wave superimposed on rated load, (JEDEC Method) (Note3, Fig.6)	I_{FSM}	300	Amps
Operating junction and Storage Temperature Range.	T_J, T_{STG}	-55 to +150	°C
Typical thermal resistance junction to lead	$R_{\theta JL}$	15	°C/W
Typical thermal resistance junction to ambient	$R_{\theta JA}$	75	°C/W

Notes: 1. Non-repetitive current pulse, per Fig.3 and derated above $T_A=25^\circ\text{C}$ per Fig.2.

2. Mounted on 8.0mm×8.0mm copper pads to each terminal.

3. 8.3ms single half sine-wave, or equivalent square wave, duty cycle=4 pulses per minutes maximum.

Dimensions (SMC/DO-214AB)

	Symbol	Millimeters		Inches	
		Min.	Max.	Min.	Max.
	L	6.60	7.11	0.260	0.280
	D	5.59	6.22	0.220	0.245
	D1	2.90	3.20	0.114	0.126
	T	7.75	8.13	0.305	0.320
	T1	0.76	1.52	0.030	0.060
	d	-	0.203	-	0.008
	H	2.20	2.80	0.087	0.110
H1	2.06	2.62	0.079	0.103	

Electrical Characteristics ($T_A=25^\circ\text{C}$)

Part Number		Device Marking Code		Reverse Stand-Off Voltage	Breakdown Voltage @ I_T	Test Current	Maximum Clamping Voltage @ I_{PP}	Peak Pulse Current	Reverse Leakage @ V_{RWM}
Unidirectional	Bidirectional	UNI	BI	$V_{RWM}(V)$	$V_{BR}(V)$	$I_T(mA)$	$V_C(V)$	$I_{PP}(A)$	$I_R(\mu A)$
5.0SMDJ11A	5.0SMDJ11CA	5PEN	5BEN	11.0	12.20~13.50	10	18.2	275.00	800
5.0SMDJ12A	5.0SMDJ12CA	5PEP	5BEP	12.0	13.30~14.70	10	19.9	252.00	800
5.0SMDJ13A	5.0SMDJ13CA	5PEQ	5BEQ	13.0	14.40~15.90	10	21.5	233.00	500
5.0SMDJ14A	5.0SMDJ14CA	5PER	5BER	14.0	15.60~17.20	10	23.2	216.00	200
5.0SMDJ15A	5.0SMDJ15CA	5PES	5BES	15.0	16.70~18.50	1	24.4	205.00	100
5.0SMDJ16A	5.0SMDJ16CA	5PET	5BET	16.0	17.80~19.70	1	26.0	193.00	50
5.0SMDJ17A	5.0SMDJ17CA	5PEU	5BEU	17.0	18.90~20.90	1	27.6	181.00	20
5.0SMDJ18A	5.0SMDJ18CA	5PEV	5BEV	18.0	20.00~22.10	1	29.2	172.00	10
5.0SMDJ20A	5.0SMDJ20CA	5PEW	5BEW	20.0	22.20~24.50	1	32.4	155.00	5
5.0SMDJ22A	5.0SMDJ22CA	5PEX	5BEX	22.0	24.40~26.90	1	35.5	141.00	5
5.0SMDJ24A	5.0SMDJ24CA	5PEZ	5BEZ	24.0	26.70~29.50	1	38.9	129.00	2
5.0SMDJ26A	5.0SMDJ26CA	5PFE	5BFE	26.0	28.90~31.90	1	42.1	119.00	2
5.0SMDJ28A	5.0SMDJ28CA	5PFG	5BFG	28.0	31.10~34.40	1	45.4	110.00	2
5.0SMDJ30A	5.0SMDJ30CA	5PFK	5BFK	30.0	33.30~36.80	1	48.4	103.00	2

Electrical Characteristics (T_A=25°C)

Part Number		Device Marking Code		Reverse Stand-Off Voltage	Breakdown Voltage @I _T	Test Current	Maximum Clamping Voltage @I _{PP}	Peak Pulse Current	Reverse Leakage @V _{RWM}
Unidirectional	Bidirectional	UNI	BI	V _{RWM} (V)	V _{BR} (V)	I _T (mA)	V _C (V)	I _{PP} (A)	I _R (μA)
5.0SMDJ33A	5.0SMDJ33CA	5PFM	5BFM	33.0	36.70~40.60	1	53.3	93.90	2
5.0SMDJ36A	5.0SMDJ36CA	5PFP	5BFP	36.0	40.00~44.20	1	58.1	86.10	2
5.0SMDJ40A	5.0SMDJ40CA	5PFR	5BFR	40.0	44.40~49.10	1	64.5	77.60	2
5.0SMDJ43A	5.0SMDJ43CA	5PFT	5BFT	43.0	47.80~52.80	1	69.4	72.10	2
5.0SMDJ45A	5.0SMDJ45CA	5PFV	5BFV	45.0	50.00~55.30	1	72.7	68.80	2
5.0SMDJ48A	5.0SMDJ48CA	5PFX	5BFX	48.0	53.30~58.90	1	77.4	64.70	2
5.0SMDJ51A	5.0SMDJ51CA	5PFZ	5BFZ	51.0	56.70~62.70	1	82.4	60.70	2
5.0SMDJ54A	5.0SMDJ54CA	5PGE	5BGE	54.0	60.00~66.30	1	87.1	57.50	2
5.0SMDJ58A	5.0SMDJ58CA	5PGG	5BGG	58.0	64.40~71.20	1	93.6	53.50	2
5.0SMDJ60A	5.0SMDJ60CA	5PGK	5BGK	60.0	66.70~73.70	1	96.8	51.70	2
5.0SMDJ64A	5.0SMDJ64CA	5PGM	5BGM	64.0	71.10~78.60	1	103.0	48.60	2
5.0SMDJ70A	5.0SMDJ70CA	5PGP	5BGP	70.0	77.80~86.00	1	113.0	44.30	2
5.0SMDJ75A	5.0SMDJ75CA	5PGR	5BGR	75.0	83.30~92.10	1	121.0	41.40	2
5.0SMDJ78A	5.0SMDJ78CA	5PGT	5BGT	78.0	86.70~95.80	1	126.0	39.70	2
5.0SMDJ85A	5.0SMDJ85CA	5PGV	5BGV	85.0	94.40~104.00	1	137.0	36.50	2
5.0SMDJ90A	5.0SMDJ90CA	5PGX	5BGX	90.0	100.00~111.00	1	146.0	34.30	2
5.0SMDJ100A	5.0SMDJ100CA	5PGZ	5BGZ	100.0	111.00~123.00	1	162.0	30.90	2
5.0SMDJ110A	5.0SMDJ110CA	5PHE	5BHE	110.0	122.00~135.00	1	177.0	28.30	2
5.0SMDJ120A	5.0SMDJ120CA	5PHG	5BHG	120.0	133.00~147.00	1	193.0	26.00	2
5.0SMDJ130A	5.0SMDJ130CA	5PHK	5BHK	130.0	144.00~159.00	1	209.0	24.00	2
5.0SMDJ150A	5.0SMDJ150CA	5PHM	5BHM	150.0	167.00~185.00	1	243.0	20.60	2
5.0SMDJ160A	5.0SMDJ160CA	5PHP	5BHP	160.0	178.00~197.00	1	259.0	19.30	2
5.0SMDJ170A	5.0SMDJ170CA	5PHR	5BHR	170.0	189.00~209.00	1	275.0	18.20	2

Notes: For bidirectional type having V_{RWM} of 18V and less, the I_R limit is double.

Ratings and Characteristic Curves ($T_A=25^\circ\text{C}$ unless otherwise noted)

Figure 1. Peak Pulse Power Rating Curve

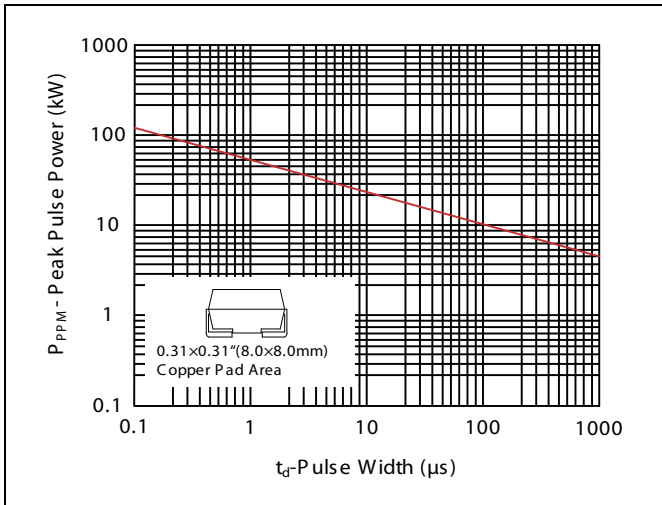

Figure 2. Pulse Derating Curve

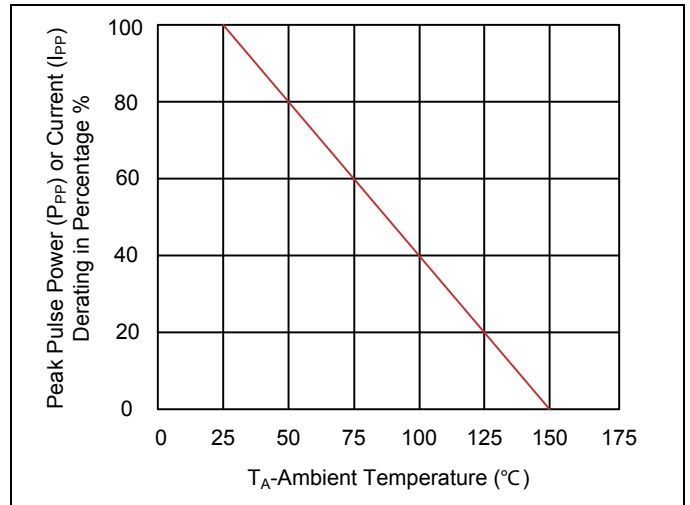

Figure 3. Pulse Waveform

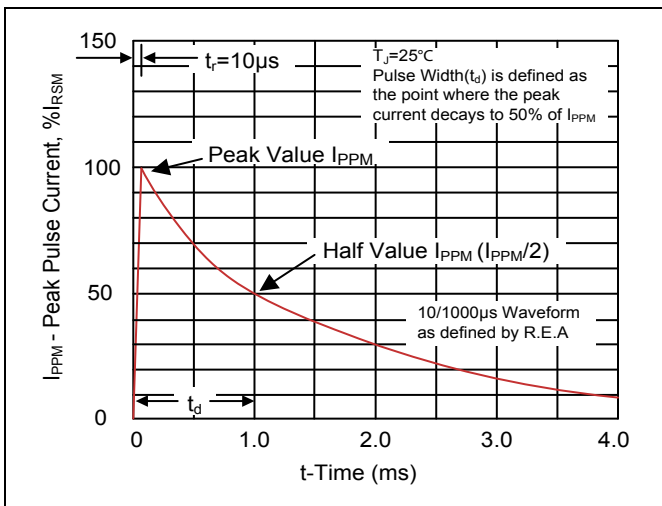

Figure 4. Typical Junction Capacitance

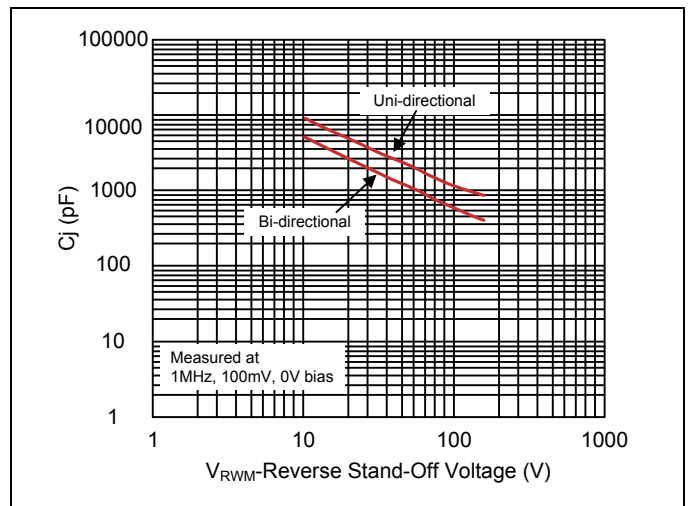

Figure 5. Steady State Power Dissipation Derating Curve

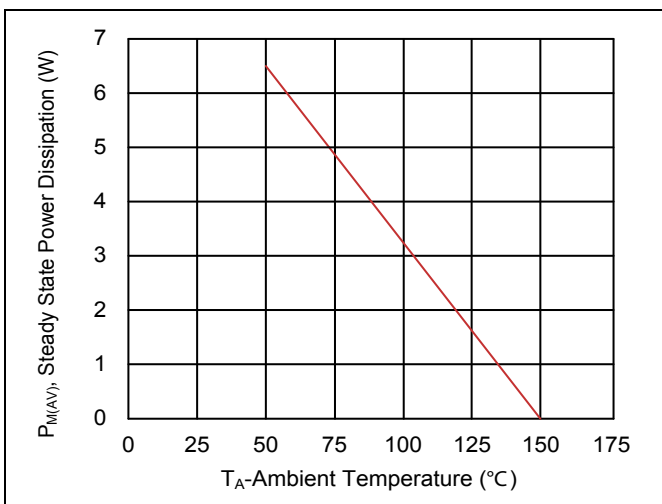
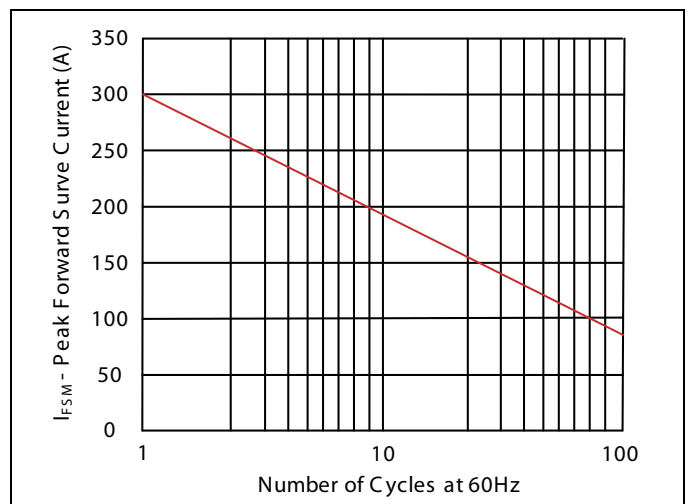
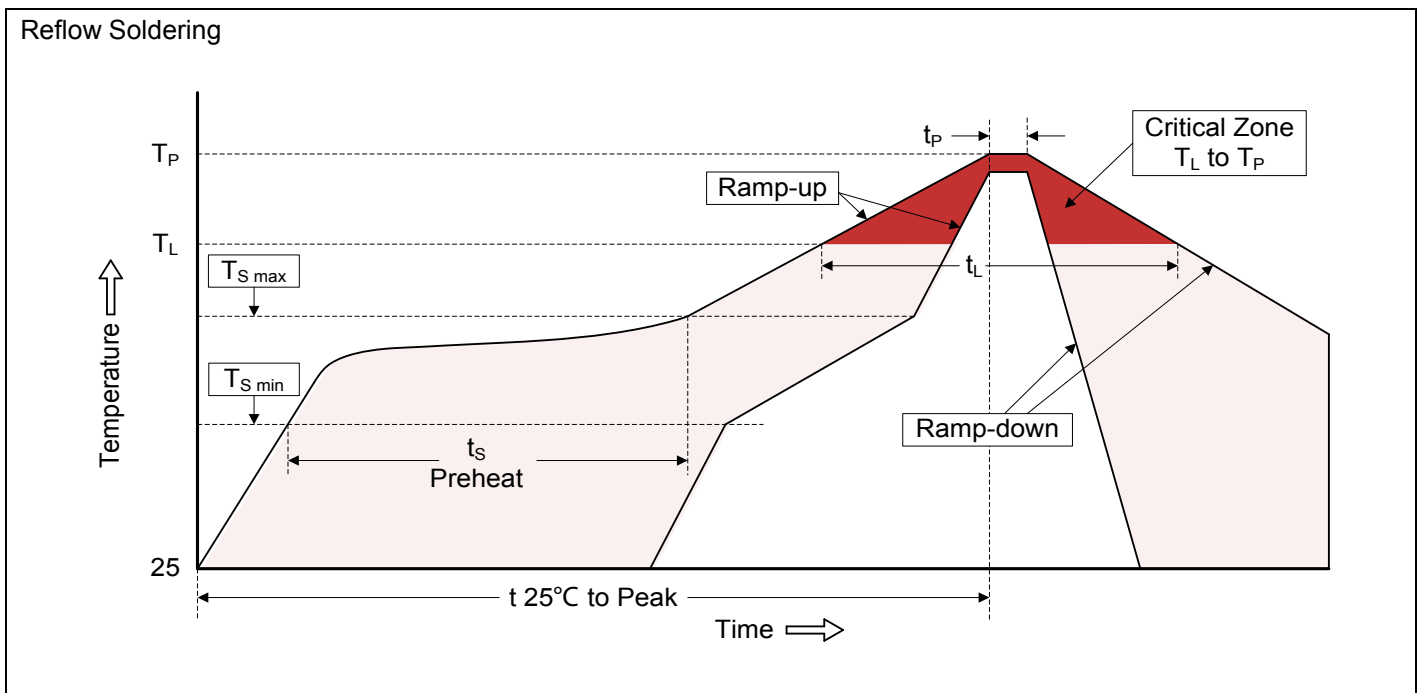

Figure 6. Maximum Non-Repetitive Forward Surge Current Uni-Directional Only



Recommended Soldering Conditions



Recommended Conditions

Profile Feature	Pb-Free Assembly
Average ramp-up rate (T_L to T_P)	3°C/second max.
Preheat	
-Temperature Min ($T_{S\ min}$)	150°C
-Temperature Max ($T_{S\ max}$)	200°C
-Time (min to max) (t_s)	60-180 seconds
$T_{S\ max}$ to T_L	
-Ramp-up Rate	3°C/second max.
Time maintained above:	
-Temperature (T_L)	217°C
-Time (t_L)	60-150 seconds
Peak Temperature (T_P)	260°C
Time within 5°C of actual Peak Temperature (t_P)	20-40 seconds
Ramp-down Rate	6°C/second max.
Time 25°C to Peak Temperature	8 minutes max.

Marking Code

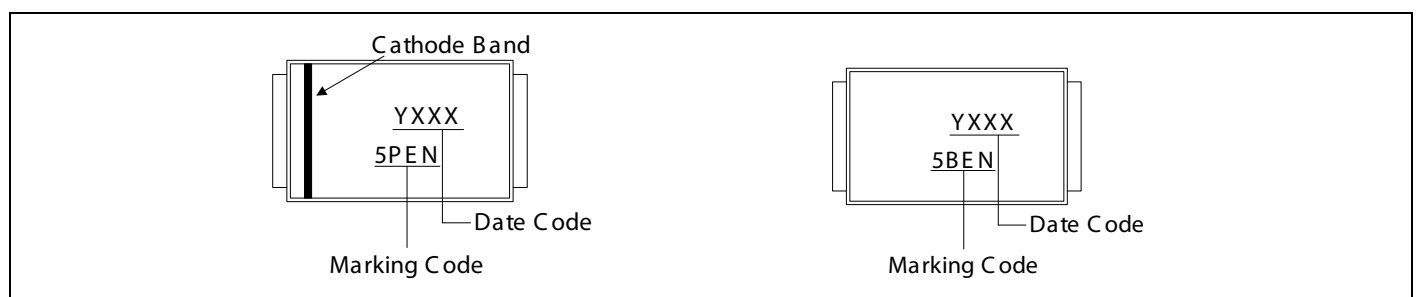

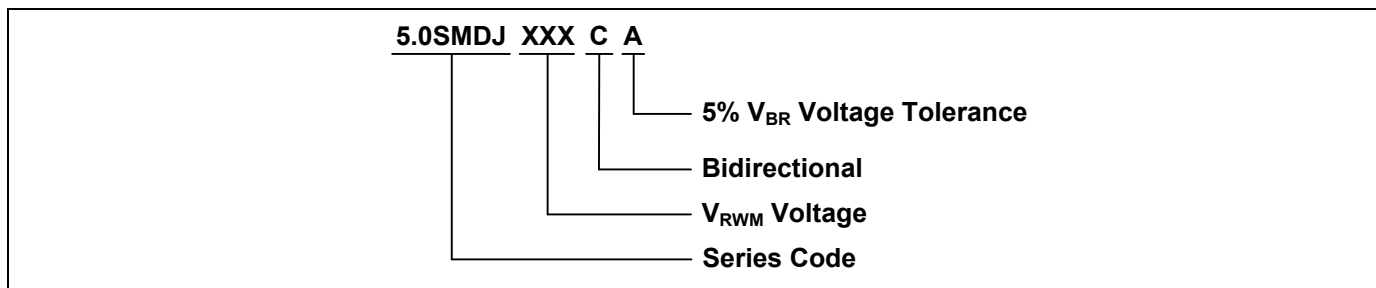
Part Number Code

Ordering Code for Different Package

7 inch reel package: Add suffix “-7” at the end of the part number, such as 5.0SMDJ70A-7

13 inch reel package: Add suffix “-13” at the end of the part number, such as 5.0SMDJ100CA-13

Packaging

Tape		Symbol	Dimension (mm)
		W	16.00±0.20
		P0	4.00±0.10
		P1	8.00±0.10
		P2	2.00±0.10
		D0	Φ 1.5±0.10
		D1	Φ 1.5±0.10
		E	1.75±0.10
		F	7.50±0.10
		A0	6.27±0.15
		B0	8.30±0.10
		K0	3.15±0.15
		T	0.30±0.05
		7" Reel	
		D3	Φ 50.0Min.
		D4	Φ 13.0±0.5
		W1	20.0 ±2.0
		Quantity: 500PCS	
13" Reel		D5	Φ 330.0±2.0
		D6	Φ 13.5±0.5
		H	2.5±1.0
		W2	20.0±2.0
		Quantity: 3000PCS	